



Main

| | |
|-------------------------------|--|
| Range of product | OsiSense ATEX D |
| Series name | Standard format |
| Product or component type | Limit switch |
| Device short name | XCMD |
| Sensor design | Miniature |
| Body type | Fixed |
| Head type | M12 plunger head |
| Material | Metal |
| Fixing mode | By the head |
| Movement of operating head | Linear |
| Type of operator | Steel spring return roller plunger |
| Switch actuation | By 30° cam |
| Type of approach | Lateral approach, 2 directions |
| Electrical connection | Fixed cable |
| Number of poles | 4 |
| Contacts type and composition | 2 x (1 NC + 1 NO) |
| Contacts insulation form | Zb |
| Contact operation | Snap action |
| Number of steps | 1 |
| Positive opening | With |
| Minimum force for tripping | 7 N |
| Maximum actuation speed | 0.1 m/s |
| IP degree of protection | IP66 conforming to IEC 60529 IP67 conforming to IEC 60529 |

Complementary

| | |
|--------------------------|--------------------------|
| Body material | Zamak |
| Head material | Zamak |
| Cable length | 5 m |
| Cable composition | 9 x 0.34 mm ² |
| Wire insulation material | PvR |

Disclaimer: This documentation is not intended as a substitute for and is not to be used for determining suitability or reliability of these products for specific user applications

| | |
|---|---|
| Positive opening minimum force | 35 N |
| Minimum actuation speed | 0.01 m/min |
| Contact code designation | C300, AC-15 (240 V, I _e = 0.75 A) conforming to EN 60947-5-1 C300, AC-15 (240 V, I _e = 0.75 A) conforming to IEC 60947-5-1 appendix A R300, DC-13 (250 V, I _e = 0.1 A) conforming to EN 60947-5-1 R300, DC-13 (250 V, I _e = 0.1 A) conforming to IEC 60947-5-1 appendix A |
| [I _{the}] conventional enclosed thermal current | 3 A AC |
| [U _i] rated insulation voltage | 300 V conforming to CSA C22.2 No 14 400 V, pollution degree: 3 conforming to IEC 60947-1 300 V conforming to UL 508 |
| Resistance across terminals | <= 25 MOhm conforming to IEC 60255-7 category 3 |
| [U _{imp}] rated impulse withstand voltage | 4 kV conforming to IEC 60664 4 kV conforming to IEC 60947-1 |
| Short-circuit protection | 6 A cartridge fuse, type gG |
| Electrical durability | 5000000 cycles DC-13 24 V 3 W, <= 3600 cyc/mn load factor: 0.5 conforming to IEC 60947-5-1 appendix C inductive DC 5000000 cycles DC-13 48 V 2 W, <= 3600 cyc/mn load factor: 0.5 conforming to IEC 60947-5-1 appendix C inductive DC 5000000 cycles DC-13 120 V 1 W, <= 3600 cyc/mn load factor: 0.5 conforming to IEC 60947-5-1 appendix C inductive DC |
| Mechanical durability | 10000000 cycles |
| Marking | II2 D-Ex tb IIIC T85°C Db IP66/67 |
| Width | 30 mm |
| Height | 50 mm |
| Depth | 16 mm |

Environment

| | |
|---------------------------------------|--|
| Shock resistance | 25 gn for 18 ms conforming to IEC 60068-2-27 |
| Vibration resistance | 5 gn 10...500 Hz IEC 60068-2-6 |
| Electrical shock protection class | Class I conforming to IEC 61140 Class I conforming to NF C 20-030 |
| Ambient air temperature for operation | -20...60 °C |
| Protective treatment | TC |
| Dust zone | Zone 21 - 22 |
| Product certifications | IEC-Ex INE 17.0020X INERIS 04ATEX0014X |
| Standards | EN/IEC 60079-0 EN/IEC 60079-31 |
| Directives | 2014/34/EU - ATEX directive |

Offer Sustainability

| | |
|----------------------------------|---|
| RoHS (date code: YYWW) | Compliant - since 1001 - Schneider Electric declaration of conformity Schneider Electric declaration of conformity |
| Product environmental profile | Available Product Environmental Profile |
| Product end of life instructions | Available End of Life Information |

Contractual warranty

| | |
|-----------------|-----------|
| Warranty period | 18 months |
|-----------------|-----------|

Dimensions

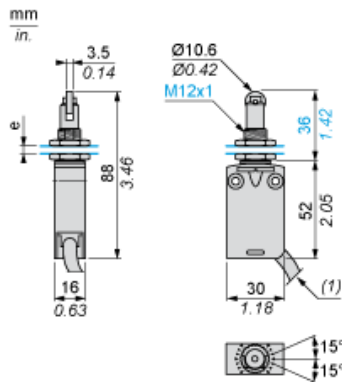

- (1) External diameter of cable 7.5 mm.
e : 8 mm max, panel cut-out Ø 12.5 mm.

Mounting

Sweep of Connecting Cable

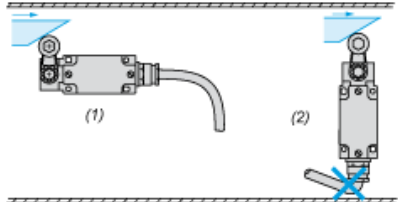

- (1) Recommended
- (2) To be avoided

Panel Mounting

Mounting and Fixing Limit Switches by the Head

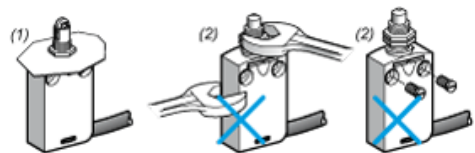

- (1) Recommended
- (2) Forbidden

Setting-up

Plunger or Multi-directional Heads

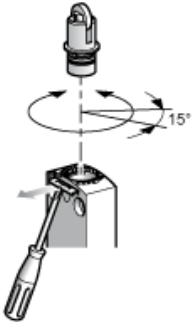

Wiring Diagram

4-pole NC + NC + NO + NO Snap Action

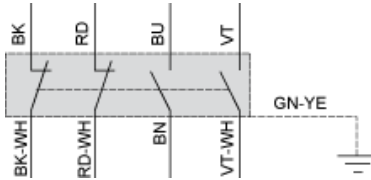

- (BK) Black
- (BK-WH) Black White
- (RD) Red
- (RD-WH) Red White
- (BU) Blue
- (BN) Brown
- (VT) Violet White
- (VT-WH) Violet White
- (GN-YE) Green Yellow

Characteristics of Actuation

Switch Actuation by 30° Cam

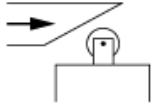

Functional Diagram

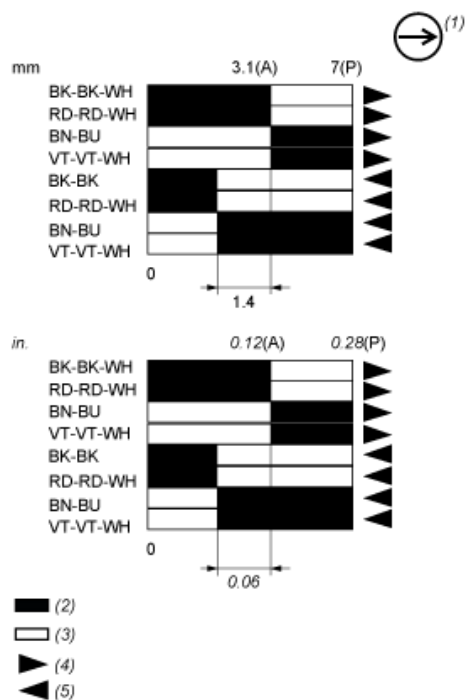

- (P) Positive opening point
- (A) Cam displacement
- (1) NC contact with positive opening operation
- (2) Closed
- (3) Open
- (4) Tripping
- (5) Resetting
- (BK) Black
- (BK-WH) Black White
- (RD) Red
- (RD-WH) Red White
- (BN) Brown
- (BU) Blue
- (VT) Violet
- (VT WH) Violet White