

Switching 75 to 150 A at 240 to 440 VAC

- Easy-to-mount monoblock construction incorporating heat sink.
- Replaceable power cartridge.
- Built-in operation indicator and varistor.
- A series of high-voltage (440 V) models available.

 Refer to *Safety Precautions for All Solid State Relays*.



Model Number Structure

Model Number Legend

G3NH-□□□□
 1 2 3 4 5

1. Basic Model Name

G3NH: Solid State Relay

2. Rated Load Power Supply Voltage

2: 200 VAC
 4: 400 VAC

3. Rated Load Current

075: 75 A
 150: 150 A

4. Terminal Type

B: Screw terminals

5. Zero Cross Function

Blank: Equipped with zero cross function

Ordering Information

List of Models

Isolation	Zero cross function	Indicator	Rated output load	Rated input voltage	Model
Photocoupler	Yes	Yes	75 A at 100 to 240 VAC	5 to 24 VDC	G3NH-2075B
			75 A at 180 to 440 VAC	100 to 240 VAC	G3NH-4075B
			150 A at 100 to 240 VAC		G3NH-2150B
			150 A at 180 to 440 VAC		G3NH-4150B

The built-in Thyristor Modules can be replaced. Refer to the table on page 3 for the model number.

Note: When ordering, specify the rated input voltage.

Specifications

■ Ratings (at an Ambient Temperature of 25°C)

Input

Rated voltage	Operating voltage	Impedance (Input current)	Voltage level	
			Must operate voltage	Must release voltage
5 to 24 VDC	4 to 30 VDC	5 mA max.*	4 VDC max.	1 VDC min.
100 to 240 VAC	75 to 264 VAC	41 kΩ±20%	75 VAC max.	20 VAC min.

*G3NH converts the input current into a constant current.

Output

Model	Applicable load			
	Rated load voltage	Load voltage range	Load current (See note.)	Inrush current
G3NH-2075B	100 to 240 VAC	75 to 264 VAC	1 to 75 A	800 A (60 Hz, 1 cycle)
G3NH-4075B	180 to 440 VAC	150 to 484 VAC		
G3NH-2150B	100 to 240 VAC	75 to 264 VAC	1 to 150 A	1,800 A (60 Hz, 1 cycle)
G3NH-4150B	180 to 440 VAC	150 to 484 VAC		

Note: The load current varies depending on the ambient temperature. Refer to *Load Current vs. Ambient Temperature* under *Engineering Data* for details.

■ Characteristics

Item	G3NH-2075B	G3NH-4075B	G3NH-2150B	G3NH-4150B
Operate time	1/2 of load power source cycle + 1 ms max. (DC input) 3/2 of load power source cycle + 1 ms max. (AC input)			
Release time	1/2 of load power source cycle + 1 ms max. (DC input) 3/2 of load power source cycle + 1 ms max. (AC input)			
Output ON voltage drop	1.6 V (RMS) max.			
Leakage current	30 mA max. (at 200 VAC)	60 mA max. (at 400 VAC)	30 mA max. (at 200 VAC)	60 mA max. (at 400 VAC)
Insulation resistance	100 MΩ min. (at 500 VDC)			
Dielectric strength	2,500 VAC, 50/60 Hz for 1 min			
Vibration resistance	Destruction: 10 to 55 to 10 Hz, 0.375-mm single amplitude			
Shock resistance	Destruction: 500 m/s ²			
Ambient temperature	Operating: -30°C to 80°C (with no icing or condensation) Storage: -30°C to 100°C (with no icing or condensation)			
Ambient humidity	Operating: 45% to 85%			
Weight	Approx. 1.8 kg		Approx. 3.0 kg	

Engineering Data

Load Current vs. Ambient Temperature

G3NH-□075B, G3NH-□150B

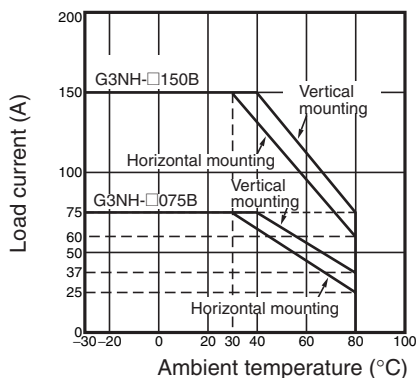

One Cycle Surge Current: Non-repetitive

Note: Keep the inrush current to half the rated value if it occurs repeatedly.

G3NH-□075B, G3NH-□150B

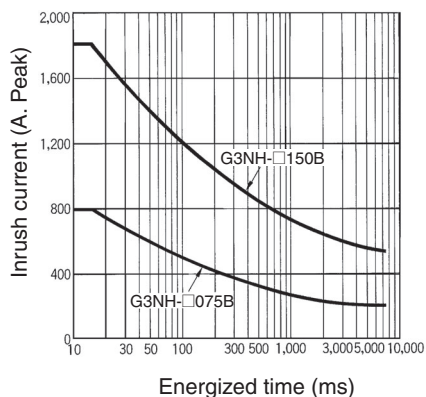

Input Current vs. Input Impedance

G3NH (4 to 30 VDC)

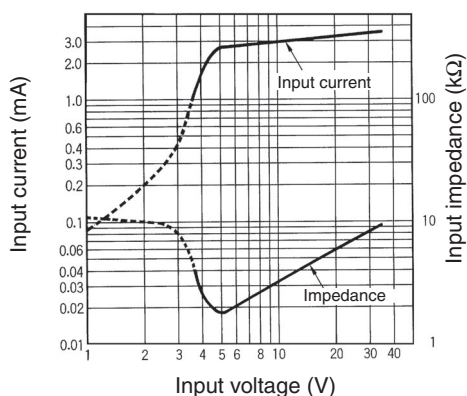

G3NH (75 to 264 VAC)

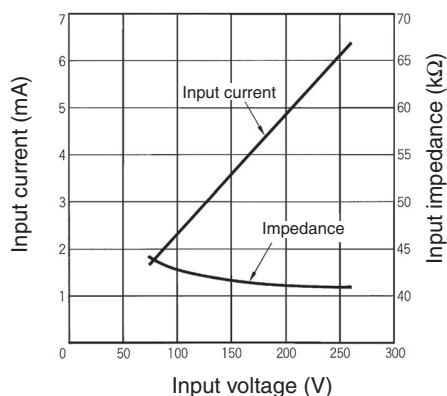

Operation

■ Replacement Parts

G32A-N Thyristor Module

If the thyristor module is damaged, replace it with a new one.

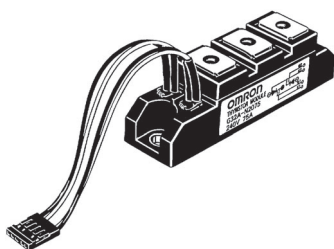

Name	Applicable load	Applicable Relay	Model
Thyristor module	75 A at 75 to 264 VAC	G3NH-2075B	G32A-N2075
	75 A at 150 to 484 VAC	G3NH-4075B	G32A-N4075
	150 A at 75 to 264 VAC	G3NH-2150B	G32A-N2150
	150 A at 150 to 484 VAC	G3NH-4150B	G32A-N4150

Replacement

Be sure to turn off the power before replacement.

1. First, remove the four screws (shown below as "A") and the transparent protective cover from the relay housing and then disconnect the wiring.

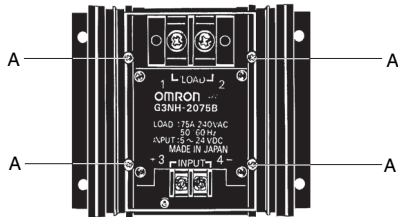

2. Remove the four screws (shown in the following as "B") and the nameplate from the relay housing.

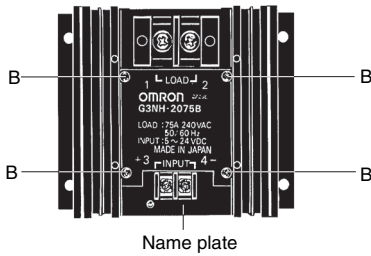

3. Remove the three screws (shown in the following as "C") from inside the housing and pull the Base Assembly up to detach. (The Base Assembly cannot be removed thoroughly because of the leads connected to the base.)

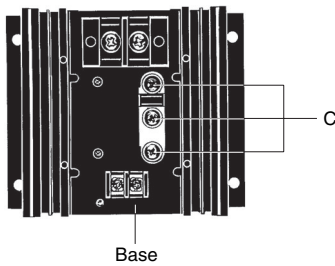

4. When the Base Assembly is detached, you will see the leads connected to the built-in thyristor module. Pull the connector to disconnect the leads. At this point, if any defect exists in any of the electronic components on the PWB, the SSR may fail again even after the replacement of the built-in thyristor module. In such a case, consult OMRON about appropriate remedial action.

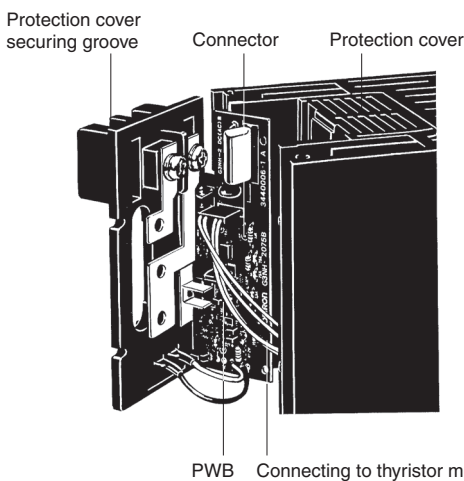

5. Remove the two screws (shown in the following as "D") and take out the built-in thyristor module.

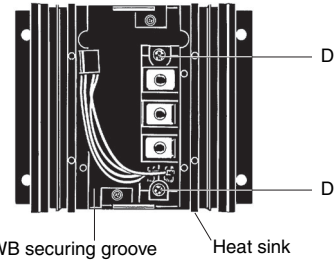

Assembly of the thyristor module must be performed in the exact reverse order of the previous disassembly steps 1 to 5.

6. Before mounting the new thyristor module for replacement, wipe off the silicone grease adhering to the heat sink, keep clean the joining surfaces of the heat sink and thyristor module, and apply the new grease (supplied as an accessory) to the joining surfaces. Secure the thyristor module to the heat sink with the two screws "D" and tighten each screw to a torque of 2.45 to 2.94 N·m.
7. Connect the thyristor module to the PWB with the socket. (The socket may be inserted in either direction.) Assemble the Base Assembly with the heat sink by aligning the PWB with the PWB securing groove and the protective cover with the protective cover securing groove, respectively, while exercising caution not to get any of the leads caught between the Base Assembly and the heat sink.
8. Secure the Base Assembly with the three screws "C". Because a large current flows into these screw parts, make sure that any of the screws is not clogged with foreign matter and tighten each screw to a torque of 4.41 to 4.90 N·m.
9. Check the assembled parts again for any lead caught between the Base Assembly and heat sink and for proper fitting of the PWB and protective cover into their respective securing grooves. Then, replace the nameplate and secure it with the four screws "B".
10. Complete the wiring and secure the protective cover with the four screws "A".
11. Apply power to the relay and check the relay for proper operation.

Dimensions

Note: All units are in millimeters unless otherwise indicated.

The orientation indicated by the external dimensions is not the correct mounting orientation. When opening mounting holes, refer to the mounting hole dimensions.

G3NH-2075B/4075B

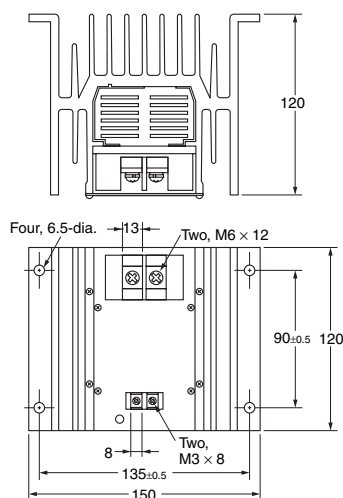
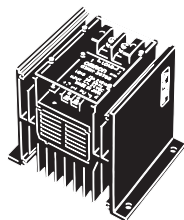

Mounting Holes

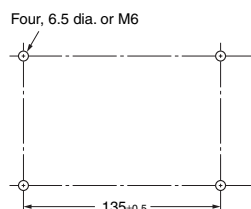

Terminal Arrangement/ Internal Connections (Top View)

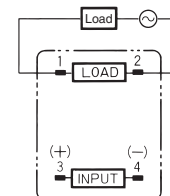

G3NH-2150B/4150B

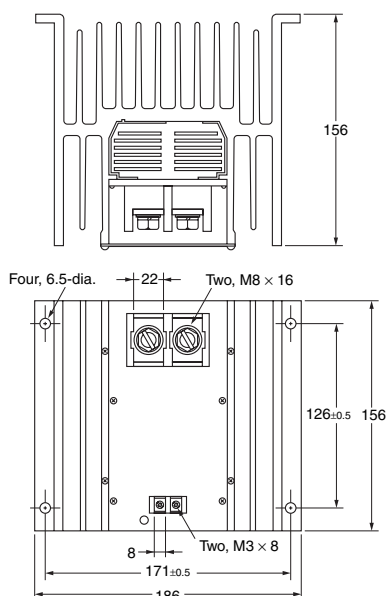
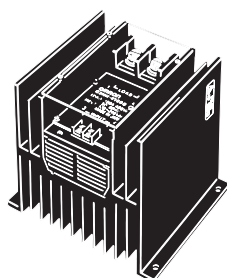

Mounting Holes

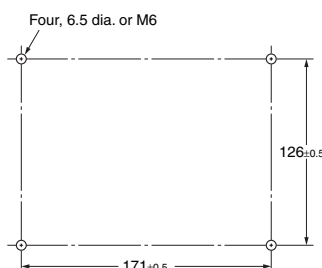

Terminal Arrangement/ Internal Connections (Top View)

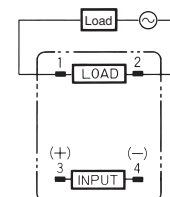

Safety Precautions

Refer to *Safety Precautions for All Solid State Relays*.

■ Precautions for Correct Use

Please observe the following precautions to prevent failure to operate, malfunction, or undesirable effect on product performance.

Load Connection

Securely tighten the LOAD terminal screws with the torque specified in the following list after you connect the load to the LOAD terminals. If the tightening torque is not enough, the terminals will generate heat.

Model	Tightening torque
G3NH-□075B	4.41 to 4.90 N·m
G3NH-□150B	8.82 to 9.80 N·m

Mounting

When you locate the G3NH near other equipment, take the heat resistivity of the equipment into consideration. The temperature of the G3NH's heat sink will rise by approximately 50°C with a rated current flow through the G3NH.

The G3NH will rise the ambient temperature. When mounting the G3NH inside a panel, install a fan for proper ventilation.

When closely mounting the G3NH Solid State Relays side by side, reduce the load current 30% lower than the specified value shown in the load current vs. ambient temperature graph.

Take proper measures so that the heat sink will be protected from dust.

ALL DIMENSIONS SHOWN ARE IN MILLIMETERS.

To convert millimeters into inches, multiply by 0.03937. To convert grams into ounces, multiply by 0.03527.

In the interest of product improvement, specifications are subject to change without notice.

Read and Understand This Catalog

Please read and understand this catalog before purchasing the products. Please consult your OMRON representative if you have any questions or comments.

Warranty and Limitations of Liability

WARRANTY

OMRON's exclusive warranty is that the products are free from defects in materials and workmanship for a period of one year (or other period if specified) from date of sale by OMRON.

OMRON MAKES NO WARRANTY OR REPRESENTATION, EXPRESS OR IMPLIED, REGARDING NON-INFRINGEMENT, MERCHANTABILITY, OR FITNESS FOR PARTICULAR PURPOSE OF THE PRODUCTS. ANY BUYER OR USER ACKNOWLEDGES THAT THE BUYER OR USER ALONE HAS DETERMINED THAT THE PRODUCTS WILL SUITABLY MEET THE REQUIREMENTS OF THEIR INTENDED USE. OMRON DISCLAIMS ALL OTHER WARRANTIES, EXPRESS OR IMPLIED.

LIMITATIONS OF LIABILITY

OMRON SHALL NOT BE RESPONSIBLE FOR SPECIAL, INDIRECT, OR CONSEQUENTIAL DAMAGES, LOSS OF PROFITS OR COMMERCIAL LOSS IN ANY WAY CONNECTED WITH THE PRODUCTS, WHETHER SUCH CLAIM IS BASED ON CONTRACT, WARRANTY, NEGLIGENCE, OR STRICT LIABILITY.

In no event shall the responsibility of OMRON for any act exceed the individual price of the product on which liability is asserted.

IN NO EVENT SHALL OMRON BE RESPONSIBLE FOR WARRANTY, REPAIR, OR OTHER CLAIMS REGARDING THE PRODUCTS UNLESS OMRON'S ANALYSIS CONFIRMS THAT THE PRODUCTS WERE PROPERLY HANDLED, STORED, INSTALLED, AND MAINTAINED AND NOT SUBJECT TO CONTAMINATION, ABUSE, MISUSE, OR INAPPROPRIATE MODIFICATION OR REPAIR.

Application Considerations

SUITABILITY FOR USE

OMRON shall not be responsible for conformity with any standards, codes, or regulations that apply to the combination of products in the customer's application or use of the products.

At the customer's request, OMRON will provide applicable third party certification documents identifying ratings and limitations of use that apply to the products. This information by itself is not sufficient for a complete determination of the suitability of the products in combination with the end product, machine, system, or other application or use.

The following are some examples of applications for which particular attention must be given. This is not intended to be an exhaustive list of all possible uses of the products, nor is it intended to imply that the uses listed may be suitable for the products:

- Outdoor use, uses involving potential chemical contamination or electrical interference, or conditions or uses not described in this catalog.
- Nuclear energy control systems, combustion systems, railroad systems, aviation systems, medical equipment, amusement machines, vehicles, safety equipment, and installations subject to separate industry or government regulations.
- Systems, machines, and equipment that could present a risk to life or property.

Please know and observe all prohibitions of use applicable to the products.

NEVER USE THE PRODUCTS FOR AN APPLICATION INVOLVING SERIOUS RISK TO LIFE OR PROPERTY WITHOUT ENSURING THAT THE SYSTEM AS A WHOLE HAS BEEN DESIGNED TO ADDRESS THE RISKS, AND THAT THE OMRON PRODUCTS ARE PROPERLY RATED AND INSTALLED FOR THE INTENDED USE WITHIN THE OVERALL EQUIPMENT OR SYSTEM.

PROGRAMMABLE PRODUCTS

OMRON shall not be responsible for the user's programming of a programmable product, or any consequence thereof.

Disclaimers

CHANGE IN SPECIFICATIONS

Product specifications and accessories may be changed at any time based on improvements and other reasons.

It is our practice to change model numbers when published ratings or features are changed, or when significant construction changes are made. However, some specifications of the products may be changed without any notice. When in doubt, special model numbers may be assigned to fix or establish key specifications for your application on your request. Please consult with your OMRON representative at any time to confirm actual specifications of purchased products.

DIMENSIONS AND WEIGHTS

Dimensions and weights are nominal and are not to be used for manufacturing purposes, even when tolerances are shown.

PERFORMANCE DATA

Performance data given in this catalog is provided as a guide for the user in determining suitability and does not constitute a warranty. It may represent the result of OMRON's test conditions, and the users must correlate it to actual application requirements. Actual performance is subject to the OMRON Warranty and Limitations of Liability.

ERRORS AND OMISSIONS

The information in this document has been carefully checked and is believed to be accurate; however, no responsibility is assumed for clerical, typographical, or proofreading errors, or omissions.

2008.11

In the interest of product improvement, specifications are subject to change without notice.

OMRON Corporation
Industrial Automation Company

<http://www.ia.omron.com/>

(c)Copyright OMRON Corporation 2008 All Right Reserved.

Mouser Electronics

Authorized Distributor

Click to View Pricing, Inventory, Delivery & Lifecycle Information:

[Omron:](#)

[G3NH-2150B AC100-240](#) [G3NH-2150B DC5-24](#) [G3NH-4075B AC100-240](#) [G3NH-4075B-DC5-24](#) [G3NH-4150B AC100-240](#) [G3NH-4150B DC5-24](#) [G3NH-2075B DC5-24](#)